

MMBT3906

PNP Transistor

Features

- PNP transistor, complementary type MMBT3904
- High stability and high reliability
- SOT-23 small outline plastic package

1. BASE
2. EMITTER
3. COLLECTOR

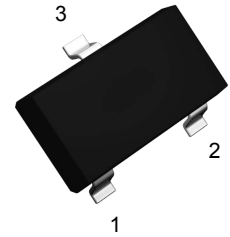

SOT-23

Absolute Maximum Ratings (T_A=25°C unless otherwise specified)

Parameter	Symbol	Max.	Unit
Collector-Base Voltage	V _{CB0}	-40	V
Collector-Emitter Voltage	V _{CEO}	-40	V
Emitter-Base Voltage	V _{EBO}	-5	V
Collector Current - Continuous	I _C	-0.2	A
Collector Power Dissipation	P _C	0.2	W
Typical Thermal Resistance from Junction to Ambient	R _{θJA}	625	°C/W
Operating Junction Temperature Range	T _J	-55 To +150	°C
Storage Temperature Range	T _{STG}	-55 To +150	°C

Electrical Characteristics (T_A=25°C unless otherwise noted)

Parameter	Symbol	Conditions	Min.	Max.	Unit
Collector-Base Breakdown Voltage	V _{(BR)CBO}	I _C =-10μA, I _E =0	-40	-	V
Collector-Emitter Breakdown Voltage	V _{(BR)CEO}	I _C =-1mA, I _B =0	-40	-	V
Emitter-Base Breakdown Voltage	V _{(BR)EBO}	I _E =-10μA, I _C =0	-5	-	V
Collector Cut-off Current	I _{CBO}	V _{CB} =-40V, I _E =0	-	-50	nA
Collector Cut-off Current	I _{CEX}	V _{CE} =-30V, V _{BE(off)} =-3V	-	-100	nA
Emitter Cut-off Current	I _{EBO}	V _{EB} =-5V, I _C =0	-	-100	nA
DC Current Gain	h _{FE}	V _{CE} =-1V, I _C =-10mA	100	300	-
		V _{CE} =-1V, I _C =-50mA	60	-	
		V _{CE} =-1V, I _C =-100mA	30	-	
Collector-Emitter Saturation Voltage	V _{CE(sat)}	I _C =-50mA, I _B =-5mA	-	-0.3	V
Base-Emitter Saturation Voltage	V _{BE(sat)}	I _C =-50mA, I _B =-5mA	-	-0.95	V
Transition Frequency	f _T	V _{CE} =-20V, I _C =-10mA, F=100MHz	300	-	MHz
Delay Time	t _d	V _{CC} =-3V, V _{BE} =-0.5V	-	35	nS
Rise Time	t _r	I _C =-10mA, I _{B1} =-1mA	-	35	nS
Storage Time	t _s	V _{CC} =-3V, I _C =-10mA	-	225	nS
Fall Time	t _f	I _{B1} =I _{B2} =-1mA	-	75	nS

Typical Electrical Characteristic Curves

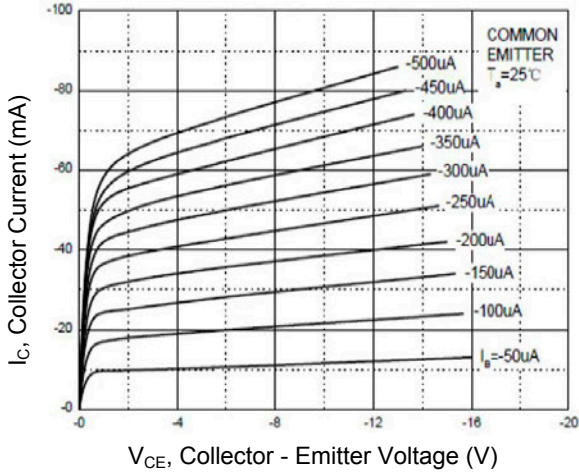

Figure 1. Static Characteristics

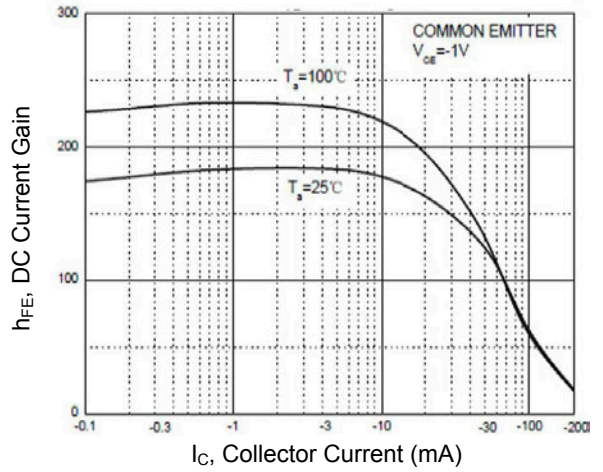

Figure 2. DC Current Gain vs. Collector Current

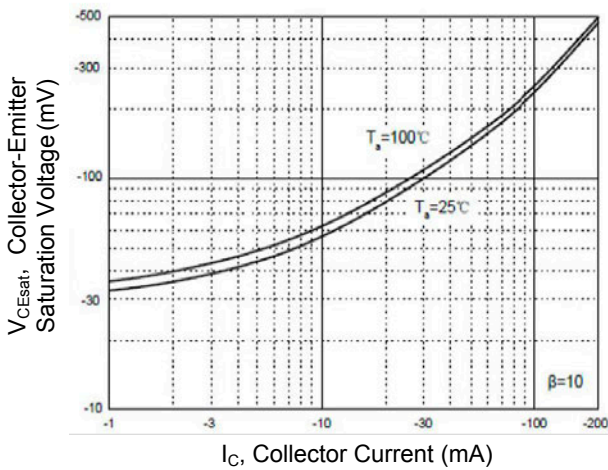

Figure 3. Collector - Emitter Saturation Voltage vs. Collector Current

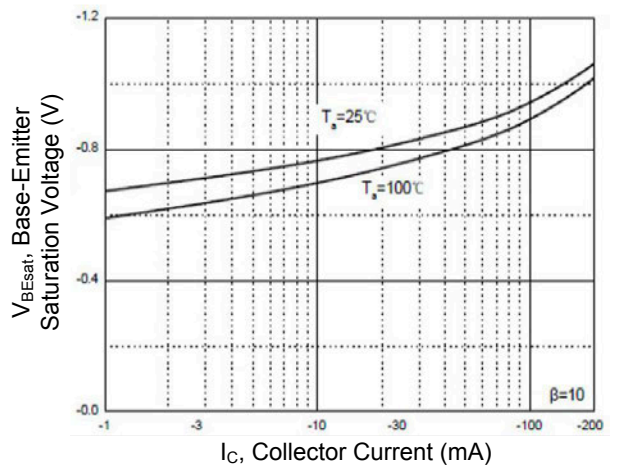

Figure 4. Base - Emitter Saturation Voltage vs. Collector Current

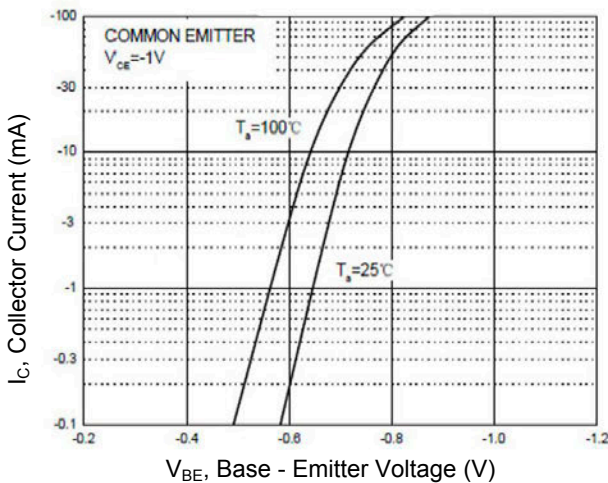

Figure 5. Collector Current vs. Base - Emitter Voltage

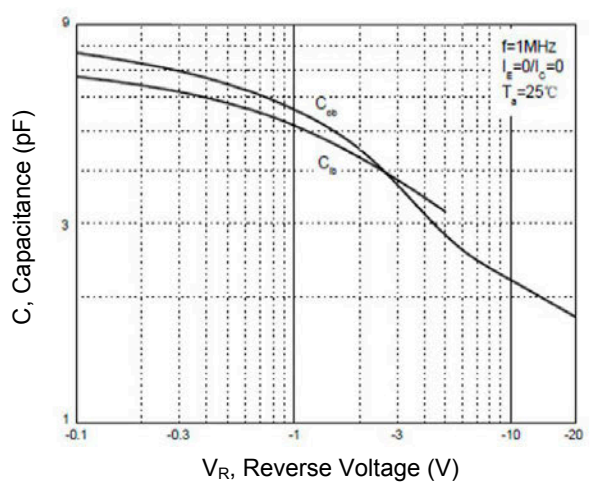

Figure 6. Capacitance Characteristics

Typical Electrical Characteristic Curves

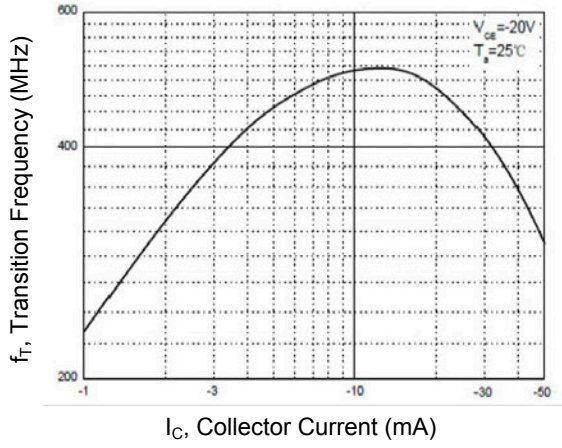

Figure 7. Transition Frequency vs. Collector Current

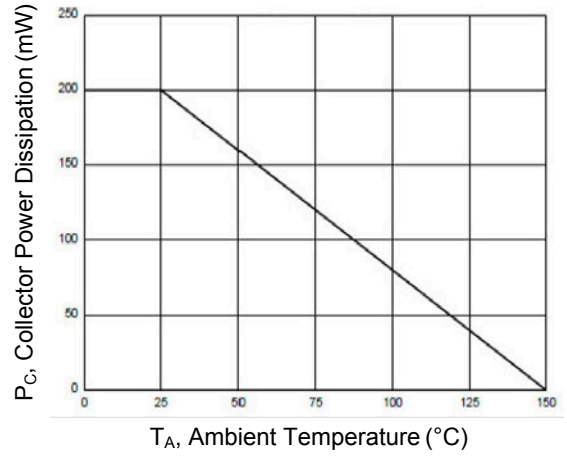
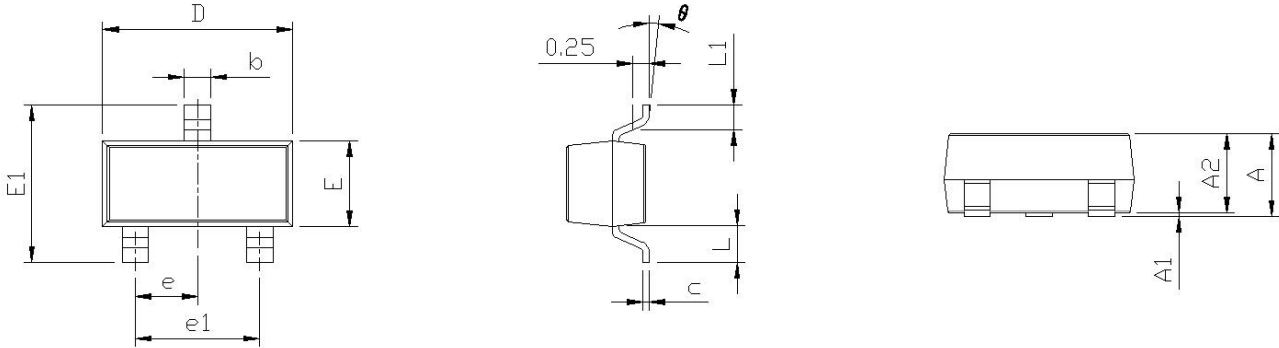

Figure 8. Power Dissipation vs Ambient Temperature

Package Outline Dimensions (SOT-23)



Symbol	Dimensions In Millimeters		Dimensions In Inches	
	Min	Max	Min	Max
A	0.900	1.150	0.035	0.045
A1	0.000	0.100	0.000	0.004
A2	0.900	1.050	0.035	0.041
b	0.300	0.500	0.012	0.020
c	0.080	0.150	0.003	0.006
D	2.800	3.000	0.110	0.118
E	1.200	1.400	0.047	0.055
E1	2.250	2.550	0.089	0.100
e	0.950 TYP		0.037 TYP	
e1	1.800	2.000	0.071	0.079
L	0.550 REF		0.022 REF	
L1	0.300	0.500	0.012	0.020
θ	0°	8°	0°	8°

Recommended Pad Layout

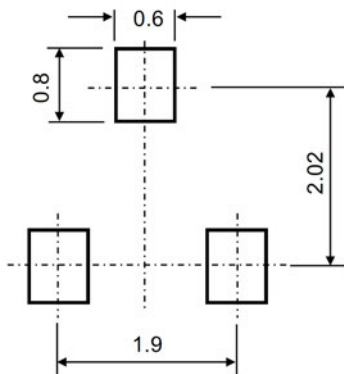

Note:

1. Controlling dimension: in millimeters
2. General tolerance: $\pm 0.05\text{mm}$
3. The pad layout is for reference purposes only

Order Information

Device	Package	Marking	Quantity	HSF Status
MMBT3906	SOT-23	2A	3000pcs / Reel	RoHS Compliant

For more information, please contact us at: inquiry@goodarksemi.com